

Product Features

- A variety of installation methods and output methods are optional
- The shell design is light and beautiful, with LCD backlight temperature and humidity dual display
- The power supply and output have over-voltage and reverse connection protection, with a high protection grade IP65
- Adopt high-precision sensors and main control, with good long-term stability and anti-interference ability



Overview

Temperature and humidity transmitter is popular in many industries. It is widely used in various fields that need to measure and control the temperature and humidity, such as workshop , station, building, meteorology, scientific research, chemical industry, hotel, medical treatment, environmental protection, food and other materials storage, HVAC, etc.

Technical Parameters

1. Relative humidity

Transducer	Digital
Measurement	10%~95%
Output	RS485/Modbus, 0~10VDC, 4~20mA optional
Accuracy	±3%@ 25°C & 20~80%RH
Response time	≤10s(25°C, Slow flow air)

2. Temperature

Transducer	Digital or thermal resistance, see selection table	
Measurement	0~50°C, -20~60°C.etc.	
Output	4~20mA, 0~10VDC, RS485/Modbus optional	
Thermal resistance	See selection table and thermal resistance indexing table	
Accuracy	Digital type: ±0.3°C@5~60°C Thermal resistance:typical±0.2~0.4°C@25°C.see selection table	
Power supply	Voltage type/485 type 15~35VDC/24VAC±20%	Current type:18.5~35VDC (RL=500Ω) /8.5~35VDC (RL=0Ω)
Output load	≤500Ω(Current type), ≥2KΩ(voltage type)	
Display	LCD display optional, with unit display and backlight (4~20mA without backlight)	
Shell material	PC housing, PC probe and polymer filter (stainless steel probe and stainless steel sintered filter optional)	
Working environment	-20~60°C,5%-95%RH (Non-condensing)	
Protection level	IP65	

Digital sensor temperature accuracy curve

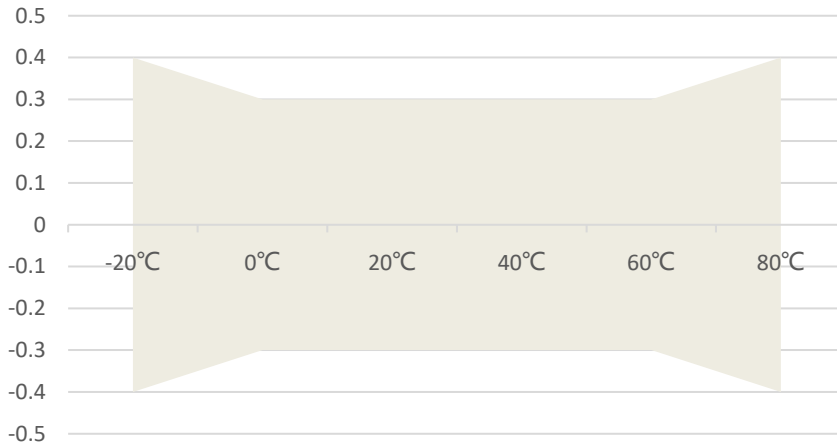

Dimensions

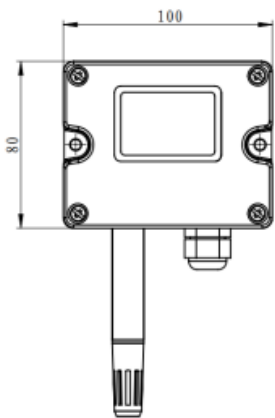

LFH101 outline dimension

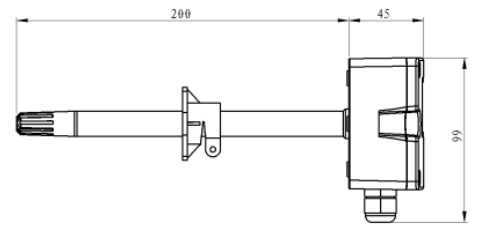
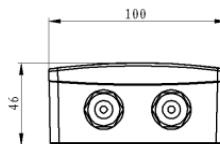
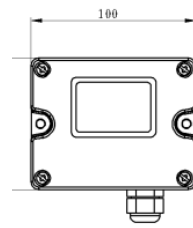
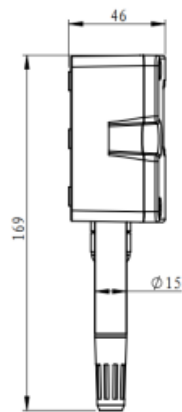

LFH102 outline dimension

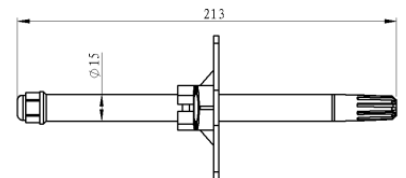

LFH103 outline dimension

Model Selection Instructions

Code and description		Remark				
LFH101-	Wall-mounted temperature and humidity transmitter	Model				
LFH102-	Duct type temperature and humidity transmitter					
LFH103-	Split type temperature and humidity transmitter					
	2	±2%RH(0.3°C)	Accuracy range			
	3	±3%RH(0.3°C)				
	V10	0~10VDC(Three-wired)	Humidity output			
	A4	4~20mA(Two-wired)				
	RS	RS485/Modbus				
	V10	0~10VDC(Three-wired)	2	NTC20K, ±0.4°C@25°C	Temperature output	
	A4	4~20mA(Two-wired)	3	Ni 1000, ±0.4°C@25°C		
	RS	RS485/Modbus	4	NTC10K-II, ±0.4°C@25°C		
	0	PT1000, ±0.2°C@25°C	5	NTC10K-III, ±0.4°C@25°C		
	1	PT100, ±0.2°C@25°C	6	NTC10K-A, ±0.4°C@25°C		
	0	NO	Temperature range			
	1	0~50°C				
	2	-20~60°C				
	8	Others (customer specified)				
	0	No display	Display mode			
	1	LCD display				
LFH101-	2	A4	3	1	1	Selection example

Note:

- The current type of LFH 101/102/103 is powered by the humidity loop, so this loop must be used, otherwise the product cannot work normally.
- Only when the temperature output option is V10 or A4, the corresponding temperature range 1-8 can be selected; otherwise, only 0 is available.
- Example: LFH101-3A4A411 means the wall-mounted type with an accuracy of 3%RH (0.3°C), humidity output 4~20mA, temperature output 4~20mA, temperature range 0~50°C with display.

Wiring instructions

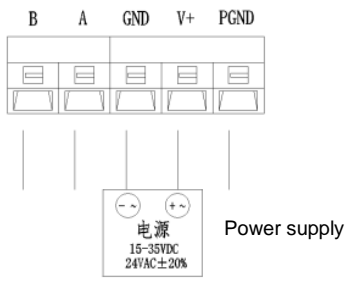

RS485 Output

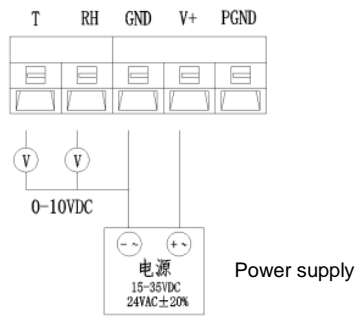

Voltage output

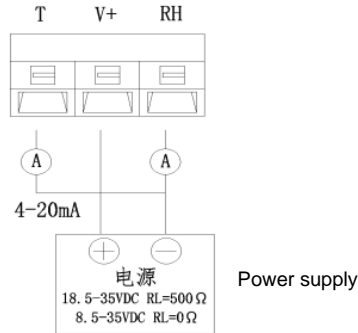

Current Output

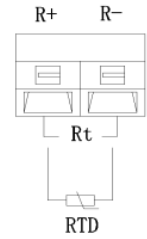

RT Output

Note: The current type output humidity circuit must be used, otherwise the product cannot be used. When the RS485 output type uses AC power, isolated 24VAC power supply is needed.

Product installation

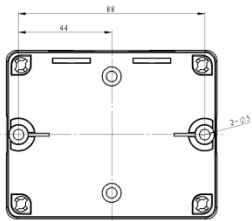

LFH101/103 Wall mounting hole

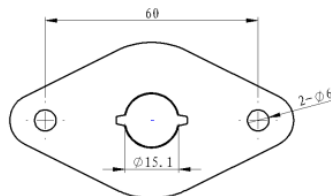

LFH102/103 Flange installation hole

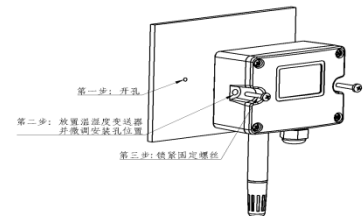

LFH101 installation image

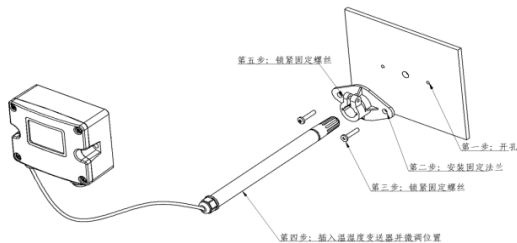

LFH102 installation image

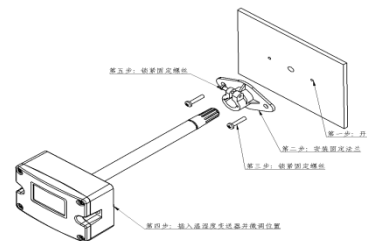

LFH103 installation image

- 1、LFH102 is recommended to use flange attachment for installation, and the insertion depth can be adjusted. Use two screws to fix the mounting flange on the duct. The screws on the flange can lock the inserted probe. The air duct opening is $\phi 15.1$ mm. After the probe is installed, the air duct should be sealed to avoid air leakage.
- 2、LFH101/103 should be vertical when wall-mounted, and pay attention to the probe facing downwards. The installation location should be far away from factors that affect the measurement, such as cold and heat sources, and should be protected from direct sunlight or rain. If necessary, a sun visor or rain cover should be installed. Open 2 fixing holes on the installation plane according to the opening hole size of the installation drawing (see the above picture), and then fix the bottom box with 2 screws. LFH103 probe tube installation description is the same as LFH102 using flange installation.
- 3、Open the upper cover, connect the power line and signal line to the bottom box through the waterproof connector, complete the wiring according to the wiring diagram, and install the upper cover back to the original. Pay attention to the sealing between the waterproof connector and the bottom box (with a sealing ring), and the sealing between the upper cover and the bottom box (with a sealing ring), so that the overall protection level reaches IP65.